

LiquaBlade™

LIQUID COOLED RECTIFIERS

HIGH POWER HOT SWAP - 3 PHASE

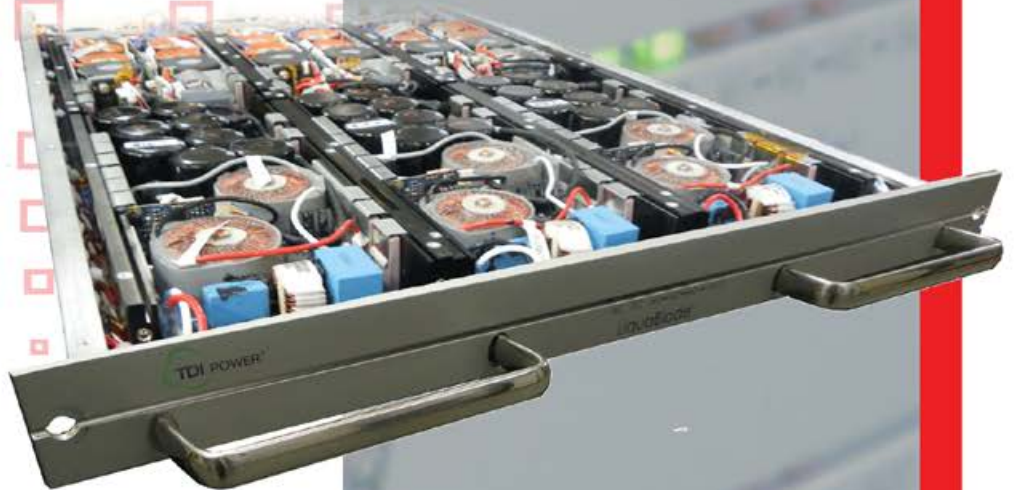
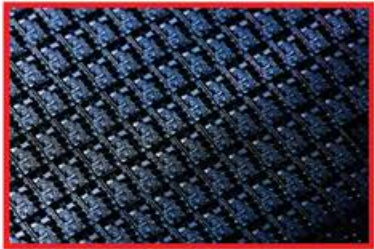

Astrodyne **TDI**
Now you have power.

POWER.

EVERYTHING DEPENDS ON IT.

When the need for power conversion is at its most demanding...its most critical... for over 50 years, the solution has been Astrodyne TDI. Today, our unmatched experience across multiple industries enables us to deliver a wide range of power-based technology solutions for some of the most well-known companies in the world. From off the shelf standard power supplies to complete customized power systems, the solution is always as close as Astrodyne TDI.

NOW YOU HAVE THE POWER.





LiquaBlade™ INTRODUCTION

The LikaBlade™ Series are the latest breed of industrial grade, high power three phase AC-DC power supplies engineered by Astrodyne TDI. These rectifiers combine advanced DC power processing, the latest silicon carbide semiconductors, patented liquid cooling and sophisticated microprocessor controls, resulting in up to 16.5 kilowatts of power in a single 1U (1.75" height) rack style package. The high frequency switch-mode design employed in LikaBlade™ offers full active power factor correction, near unity power factor and excellent output responsiveness. The wide operating AC input range of 380-480V 50/60Hz permits global three phase application usage without the need of an external step down transformer. LikaBlade is fully programmable - a perfect solution for applications that require a flexible power supply solution for their unique requirements.

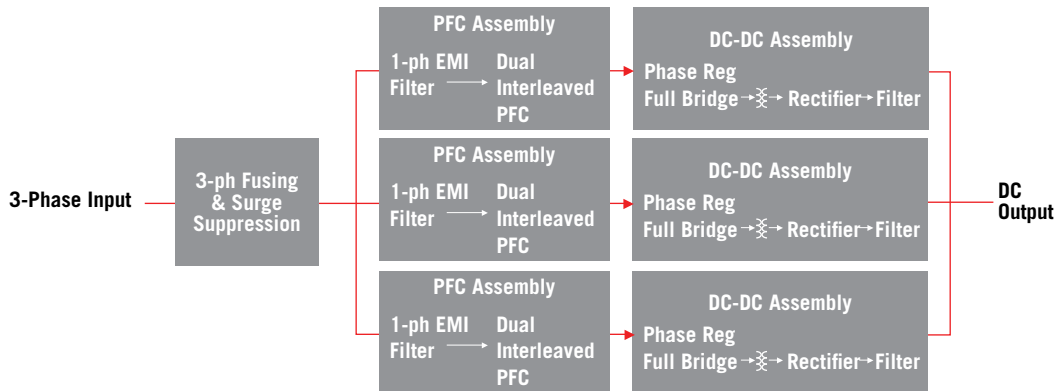

LikaBlade's Three Independent Sub-Assembly Architecture

SCALABILITY

LikaBlade can be used independently for stand alone applications, or easily paralleled for high power solutions using system controls offered by Astrodyne TDI. Advanced master control operation enables paralleling of units of upwards to 500kW in a single 52" rack. Rectifiers can be used as stand-alone power modules with CAN bus communication or in parallel groups (or power zones) using the System Controller via Ethernet and analog commands for full accessibility and operator control of the modules. Whether the unit(s) need to operate as a voltage source, current source or constant power...all are fully programmable -either factory set, or field adjustable.



**CUTTING
EDGE HIGH
FREQUENCY
SILICON
CARBIDE
MOSFET
TECHNOLOGY**





STANDARD FEATURES

All LiquaBlade modules come standard with: 16.5KW of high quality DC power, blind mate connections (AC, DC and inlet/outlet fluid port cooling), remote programming control, a comprehensive set of safety features, evaluation browser based graphical user interface, Labview drivers and more.

Environmental and cooling requirements are very significant factors to consider when selecting a power solution. Astrodyne TDI's patented cooling technology has undergone extensive testing over five generations of TDI liquid cooled power products. LiquaBlade utilizes pressure tested leak-resistant anodized connections that enable use of liquid cooling with confidence in demanding applications.

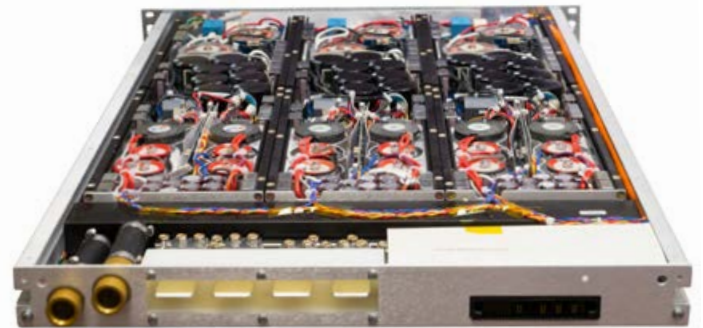

MONITORING AND CONTROL

LiqaBlade monitoring and control functionality for individual or system unit status is accessible through the use of a stand alone Controller. Individual LiqaBlades can easily be paralleled and designated as "members" of a power zone. Up to ten LiqaBlades can be paralleled within a single zone. System configuration, output set points and rectifier monitoring can be performed through either a web browser Graphical User Interface, or directly over TCP/IP. Rectifiers will routinely display and report their status to the Controller and automatically have their power redistributed in the event of a failure to provide redundant, uninterrupted zone power without operator intervention - an attractive feature for minimizing down time in critical applications.

SAFETY FEATURES

- Loss of Phase Detection
- Over Temperature Protection
- Over Voltage Protection
- Over Current Protection
- Fuse trip (and clear)

**CONTINUOUSLY
MONITORED
THROUGH THE
STANDALONE
CONTROLLER**

Astrodyne TDI
Now you have power.



KEY FEATURES

Each LiquaBlade offers a host of attractive features:

- Three Phase Delta Input (380V, 400V, 440V or 480VAC, 50/60Hz) , no neutral required
- Internally Redundant Assemblies
- 16.5kW, 60V, 360A DC Output in 1U Standard 19" Package (180 & 400V models also available)
- Unique Hot Swap (Blind Mate AC, DC, Control & Cooling Connections)

LiquaBlade with Hot Swap Shelf Assembly

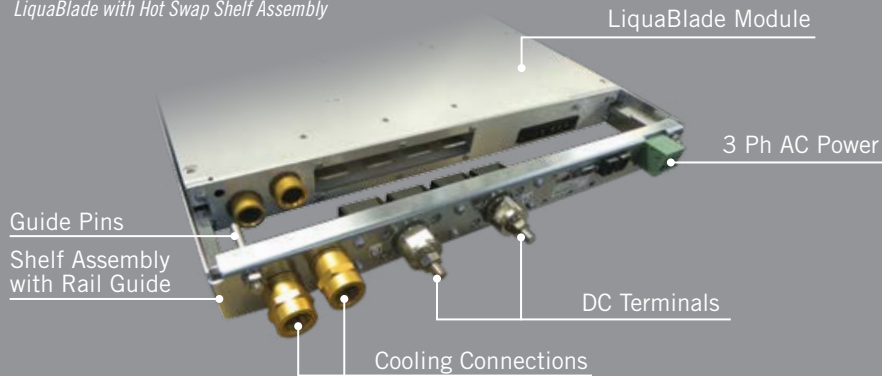

- True Active Power Factor Correction (up to 0.99PF)
- N+1 Operation*
- Highly Flexible – easily reconfigured for different power levels
- Constant Voltage, Constant Current or Constant Power Output
- Front Panel Status and Fault LEDs (AC, DC, internal sub module)
- Control Output Options: Analog 0-10V, CAN bus or Ethernet
- Monitoring and Diagnostics
 - Output Voltage (reports actual voltage)
 - Output Current (reports actual current)
 - AC Input Line Voltage Status
 - DC Output Enabled
 - Over Temperature (Fault / OK)
 - Actual Internal Operating Temperature
 - Sub-Assembly 1 (Fault / OK)
 - Sub-Assembly 2 (Fault / OK)
 - Sub-Assembly 3 (Fault / OK)
- Control
 - DC Output (Enabled / Disabled)
 - DC Output Voltage (settable in unit range)
 - DC Output Current (settable in unit range)
 - DC Output Power (settable in unit range)

* Requires LiquaRack Controller

© Copyright 2015, Astrodyne, Inc

This document is believed to be correct at time of publication and Astrodyne, Inc accepts no responsibility for consequences from printing errors or inaccuracies. Specifications are subject to change without notice

**UNIVERSAL
AC INPUT -
NO STEP
DOWN
TRANSFORMER
REQUIRED**



**EXAMPLE LAYOUT
DEMONSTRATING (3)
INDEPENDENT LIQUABLADE
ZONES WITH VARIOUS
POWER LEVELS**

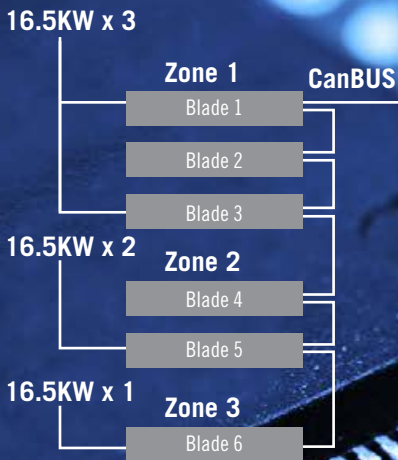

SYSTEM CONTROLLER

Monitor, Control and Administration

- Interfaces to LiquaBlade CAN Controlled Power Supplies / Rectifiers
- 1U Rack Height
- 10 Base T Ethernet Interface
- 6 Analog Interface D-Sub connectors for control of up to 6 “power zones”
- Configurable via the Ethernet Interface, 0-10V analog interface or both
- Integrated Web Server
- N+1 Redundancy Enabler for LiquaBlade Modules

Ethernet



Host
Computer

LIQUABLADE BENEFITS

- Three Phase Direct Input - no external step down transformer required
- Modular and Scalable
- Liquid Cooled Electronics = Higher Reliability
- Hot Swap Modules-Low Mean-Time-To-Repair (“MTTR”)
- High End-to-End Efficiency- maximum power, fewer losses
- Highly Competitive Total System Economics
- Proprietary Highly Accelerated Stress Screening (HASS) Process - High Reliability
- High Power Density- significant space savings

**1U HEIGHT
ENABLES
SIGNIFICANT
SPACE SAVINGS**

RACK SYSTEMS

Astrodyne TDI can offer engineered system solutions, when required.

- Rack Assemblies with Complete Bussing/Plumbing/Power Distribution
- AC Input Circuit Breaker Panel
- Multi-Zone System Controls
- Self-Contained Heat Exchange System
- Dewpoint Monitoring for Anti-Condensation Control



Astrodyne TDI
Now you have power.

© Copyright 2015, Astrodyne, Inc
This document is believed to be correct at time of publication and Astrodyne, Inc accepts no responsibility for consequences from printing errors or inaccuracies. Specifications are subject to change without notice

Outline Specifications for 60V module (other voltages available)	
AC Input	
Three Phase Delta	
AC Input Voltage Range	342 to 528V
Max AC Current per phase	31A
Frequency	47Hz to 63Hz
Power Factor (active correction)	0.99 typical (>0.93 across input range)
Efficiency	92% typical (>91% from 30% to 100% loading)
DC Output	
Voltage	60V maximum controllable down to 5V
Current	360A maximum controllable down to 0A
Protection	
Output Overvoltage	63V +/-1V, Power supply will latch off (not affected by parallel units)
Output Current Limit	358 to 362A constant current characteristic
Power Limit	Output is limited to 16.5kW
Input Overcurrent	Power limit ensures input current is limited under all operating conditions. Three internal fuses, one per phase, provide fault current protection under catastrophic conditions
Input Overvoltage	535V +/-5V Non latching protection
Input Undervoltage	335V +/-5V Non latching protection, output will inhibit if undervoltage present for >120ms
Overtemperature Protecton	Internal thermal monitoring will shut power module down if temperature is too high. Self resetting at safe temperature
Control Interface	
	CAN bus (other options available); Ethernet via controller
Environment	
Ambient Temperature Range	5°C to +50°C (Wider ranges available subject to coolant flow and maximum power)
Humidity	0% to 95% RH non-condensing
Vibration	MIL-STD-810G and IEC60068-2-64
Cooling	
Water Flow	1.5 GPM Min
Water Temperature	10°C to +55°C
Mechanical	
Dimensions (Modules & mounting sleeve combined excluding front and rear projections)	29" deep x 17.5" wide x 1.72" high (737mm x 445mm x 44mm)
Weight	46lbs (21kg)
Safety/Regulatory	UL 60950-1, 2nd Edition, EN 60950-1/A12:2011, IEC 60950-1, 2nd Edition, CE marked (LVD)

LIQUABLADE DRAWINGS

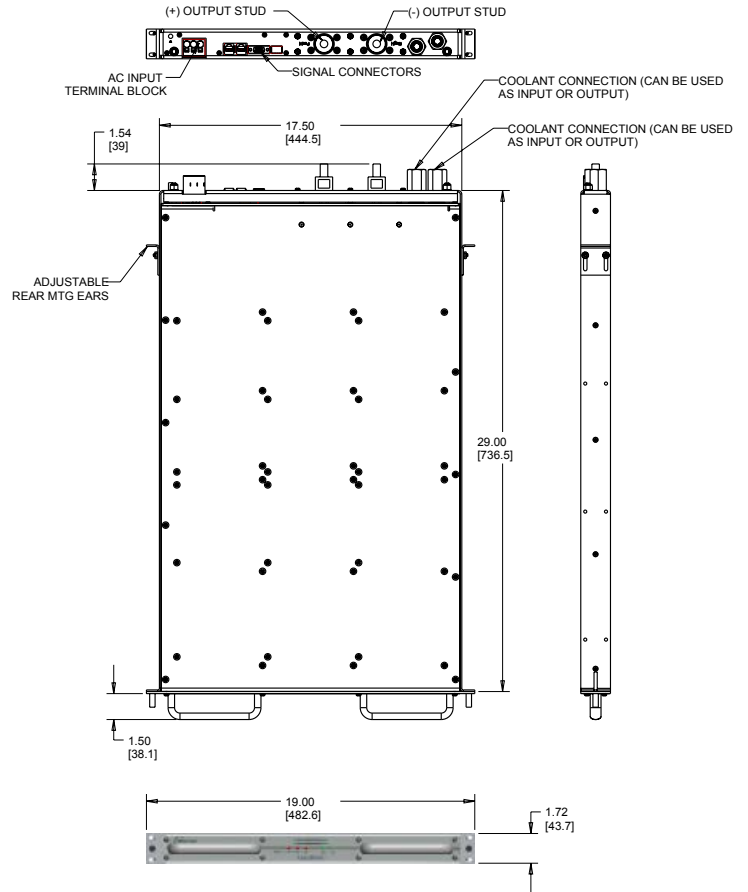

SYSTEM CONTROLLER DRAWING

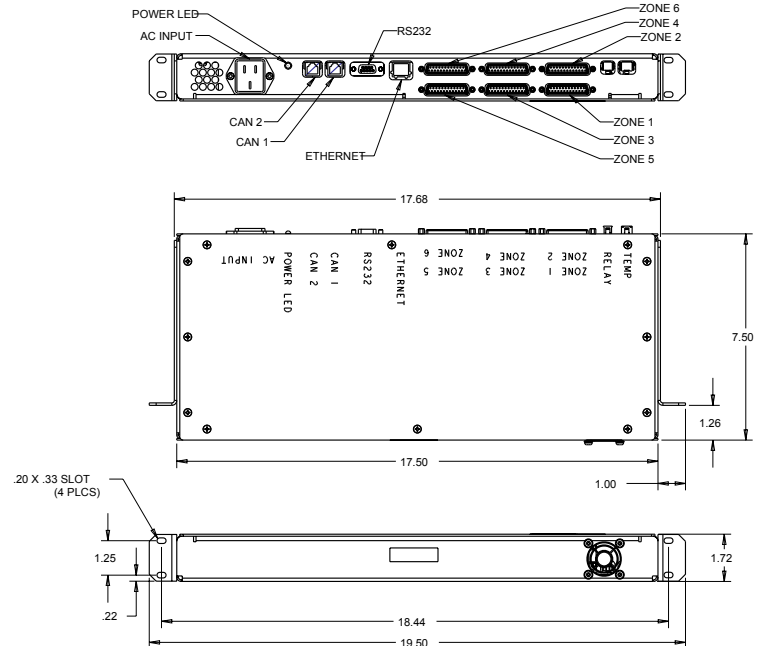

LIQUABLADE - AC/DC MODULE MODELS

*hot swap feature not available on this model

	Input Voltage(AC)	Frequency (Hz)	Output Voltage(DC)	Output Current (A)	Power(KW)
1	380-480VAC ±10%, 3Ø	50/60	0-60V	0-360	16.5
2	380-480VAC ±10%, 3Ø	50/60	0-180V	0-120	16.5
3*	200-240VAC ±10%, 3Ø	50/60	48V	0-250A	12

CONTACT ASTRODYNE TDI TODAY
WITH YOUR SPECIFIC REQUIREMENTS.

Astrodyne TDI
Now you have power.

www.AstrodyneTDI.com | +1 908-850-5088

